





















BODGERS

Today

1. Finish the Reaction Game
2. Projects

Raspberry Pi 3 GPIO Header

Pin#	NAME		NAME	Pin#
01	3.3v DC Power		DC Power 5v	02
03	GPIO02 (SDA1 , I ² C)		DC Power 5v	04
05	GPIO03 (SCL1 , I ² C)		Ground	06
07	GPIO04 (GPIO_GCLK)		(TXD0) GPIO14	08
09	Ground		(RXD0) GPIO15	10
11	GPIO17 (GPIO_GEN0)		(GPIO_GEN1) GPIO18	12
13	GPIO27 (GPIO_GEN2)		Ground	14
15	GPIO22 (GPIO_GEN3)		(GPIO_GEN4) GPIO23	16
17	3.3v DC Power		(GPIO_GEN5) GPIO24	18
19	GPIO10 (SPI_MOSI)		Ground	20
21	GPIO09 (SPI_MISO)		(GPIO_GEN6) GPIO25	22
23	GPIO11 (SPI_CLK)		(SPI_CE0_N) GPIO08	24
25	Ground		(SPI_CE1_N) GPIO07	26
27	ID_SD (I ² C ID EEPROM)		(I ² C ID EEPROM) ID_SC	28
29	GPIO05		Ground	30
31	GPIO06		GPIO12	32
33	GPIO13		Ground	34
35	GPIO19		GPIO16	36
37	GPIO26		GPIO20	38
39	Ground		GPIO21	40



Rev. 2
29/02/2016

www.element14.com/RaspberryPi

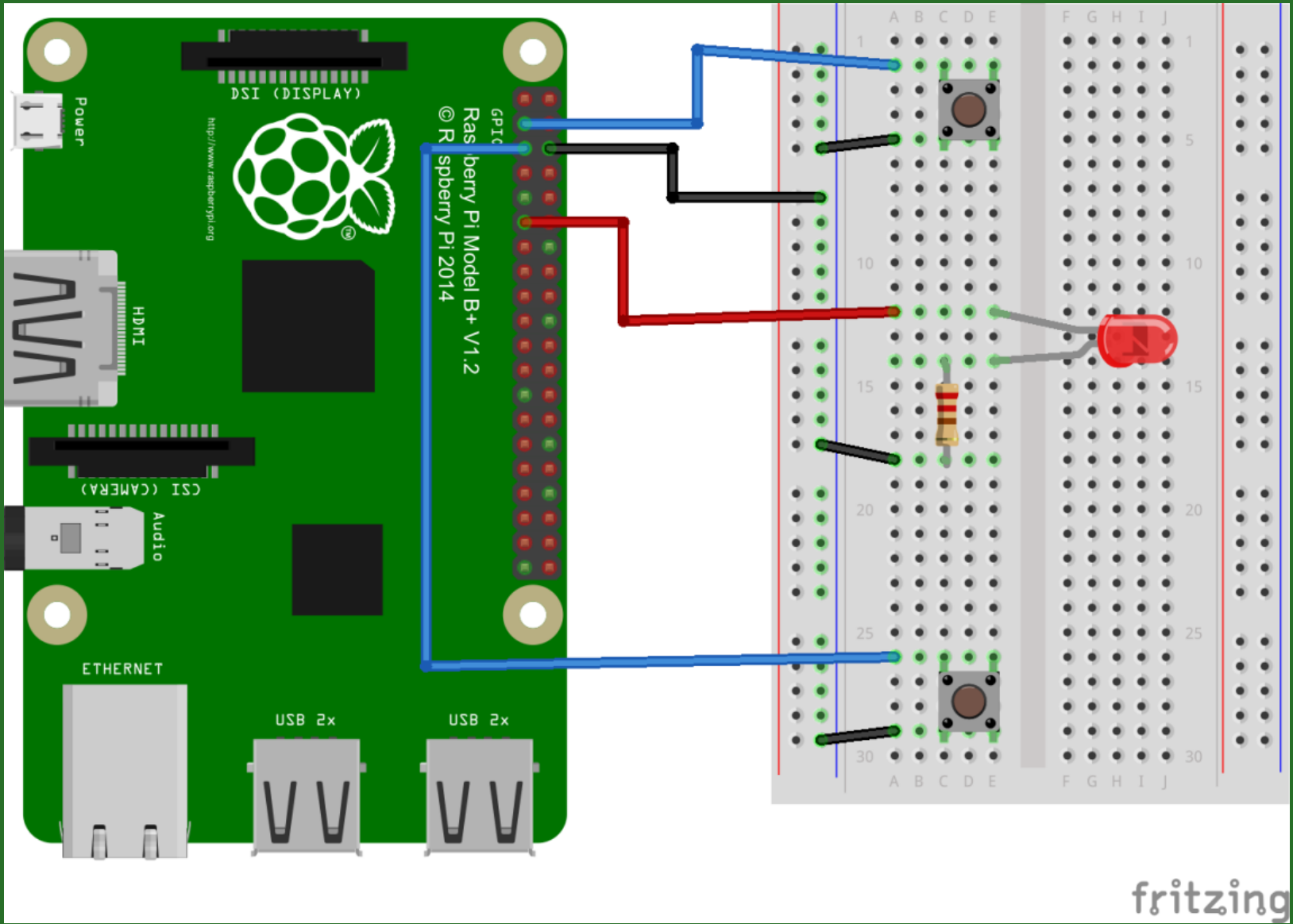

fritzing

```
from gpiozero import Button, LED
from time import sleep
import random

led = LED(17)

player_1 = Button(2)
player_2 = Button(3)

time = random.uniform(5, 10)
sleep(time)
led.on()

while True:
    if player_1.is_pressed:
        print("Player 1 wins!")
        break
    if player_2.is_pressed:
        print("Player 2 wins!")
        break

led.off()
```